

End Cap

SPECIFICATION & INSTALLATION

SPECIFICATIONS

Basic Dimensions: 1.42" (W) x .33" (H) x 84.5" (L)

Surface Material: PVC wearlayer with high-durability urethane coating

Core Material: Extruded PVC Core

Includes: Metal Track

APPLICATIONS

- Floor to carpet (turn and tack carpet)
- Transition under a door to bare floor
- To allow for expansion in front of a fixed object such as a sliding door

INSTALLATION INSTRUCTIONS

Step One: Dry fit trim pieces prior to installing floor to ensure proper fit and finish with flooring color variations.

Step Two: The metal track when installed needs to be far enough from the edge of the material to allow for the prescribed expansion space.

Step Three: Install the track with screws and/or glue to create a tight fit to the floor. Ensuring a tight fit to the floor could include trimming the base of the stem that engages into the metal track.

Step Four: Do not glue or fasten the molding directly to the material that would impede with the proper expansion and contraction of the product.

PROFILE

Technical Dimensions/Profile:

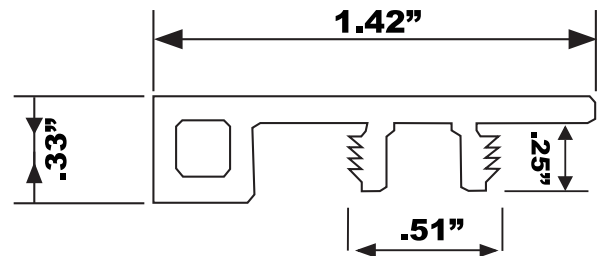

NOTES

- Recommended for residential use only.
- Track is not pre-drilled. Screws will easily penetrate the track.

Multi-Purpose Reducer

SPECIFICATION & INSTALLATION

SPECIFICATIONS

Basic Dimensions: 1.97" (W) x .31" (H) x 84.5" (L)

Surface Material: PVC wearlayer with high-durability urethane coating

Core Material: Extruded PVC Core

Includes: Metal Track

PROFILE

Technical Dimensions/Profile:

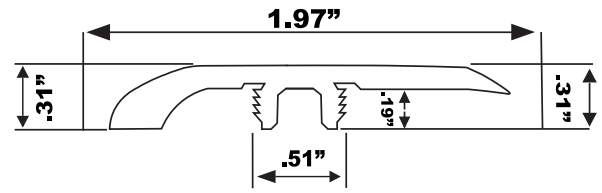

APPLICATIONS

- Reducing the height from one floor to another or from the Eastern Waterproof product to bare floor
- Two products of the same height

NOTES

- Recommended for residential use only.
- Track is not pre-drilled. Screws will easily penetrate the track.

INSTALLATION INSTRUCTIONS

Step One: Dry fit trim pieces prior to installing floor to ensure proper fit and finish with flooring color variations.

Step Two: The metal track when installed needs to be far enough from the edge of the material to allow for the prescribed expansion space.

Step Three: Install the track with screws and/or glue to create a tight fit to the floor. Ensuring a tight fit to the floor could include trimming the base of the stem that engages into the metal track.

Step Four: Do not glue or fasten the molding directly to the material that would impede with the proper expansion and contraction of the product.

Quarter Round

SPECIFICATION & INSTALLATION

SPECIFICATIONS

Basic Dimensions: .75" (W) x .75" (H) x 84.5" (L)

Surface Material: PVC wearlayer with high-durability urethane coating

Core Material: Extruded PVC Core

APPLICATIONS

- extend the floor pattern onto base to cover expansion space

INSTALLATION INSTRUCTIONS

Step One: Dry fit trim pieces prior to installing floor to ensure proper fit and finish with flooring color variations.

Step Two: The product must not rest on or be fastened through the matching flooring. Use 1mm spacers under the quarter round to ensure it does not pinch the proper expansion of the matching flooring.

Step Three: Using appropriate adhesive or a finish nailer, attach the quarter round to the existing base board with care to not pierce or pinch the flooring beneath the quarter round.

Step Four: Remove spacers and ensure there are no instances of pinched, pierced, or otherwise pressured flooring from the quarter round.

PROFILE

Technical Dimensions/Profile:

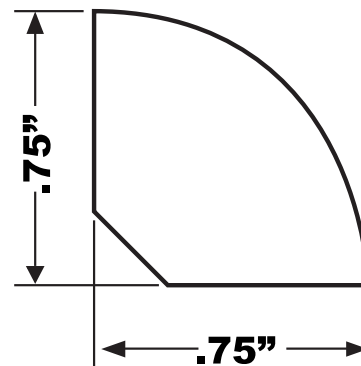

Stair Kit

SPECIFICATION & INSTALLATION

SPECIFICATIONS

Basic Dimensions:

Stair Cap: 12.6" (W) x 1.81" (total height) x 47.24" (L)

Stair Return: 15.75" (L)

Stair Risers: 7.87" (W) x .157" x 47.24" (L)

Surface Material: PVC wearlayer with high-durability urethane coating

Core Material: Extruded PVC Core

APPLICATIONS

- Box steps up to 47" in width, or open return steps up to 46" in width

INSTALLATION INSTRUCTIONS

Step One: Dry fit trim pieces prior to installing floor to ensure proper fit and finish with flooring color variations.

Step Two: The Eastern Waterproof Flooring® stair kit stair cap requires a rounded nose to support the top surfaces of the stair cap for walking traffic. If the existing step does not have one, one must be attached with glue and staples/screws.

Step Three: Clean the step to be sure it is free from debris, adhesive, or other flooring.

Step Four: Liberally apply ProVantage Heavy Duty Adhesive to the back of the stair cap before applying to the step. Follow all curing instructions recommended on the package. One tube of ProVantage Heavy Duty Adhesive will cover 3 stair caps and their corresponding risers

Step Five: To add a return, measure the angle of the open edge of the step. Cut half of that angle onto the end of the return stock and cut the return stock to depth. Using a speed square to keep the return stock upright, trace and cut the tread to allow for the return to attach flush to the tread. Glue the return stock to the side of the step and install the stair cap flush to it.

PROFILE

Technical Dimensions/Profiles:

Stair Cap

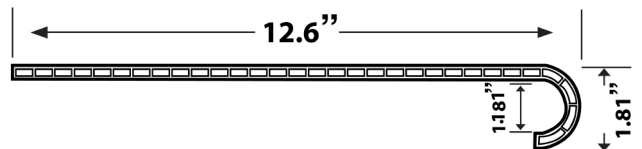

Stair Riser

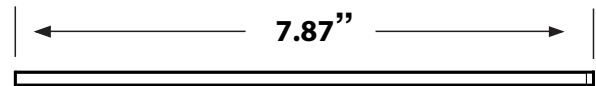

NOTES

- Recommended for residential use only.
- Stair covering is for aesthetic purposes only. It does not remedy structural problems.

Stairnose (overlap)

SPECIFICATION & INSTALLATION

SPECIFICATIONS

Basic Dimensions: 2.01" (W) x 1.5" (H) x 84.5" (L)

Surface Material: PVC wearlayer with high-durability urethane coating

Core Material: Metal

Includes: Shim (Not needed for overlap installation)

PROFILE

Technical Dimensions/Profile:

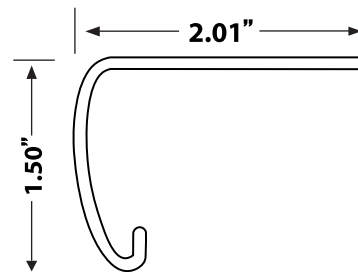

APPLICATIONS

- Step up from a sunken area or steps

NOTES

- Recommended for residential use only.
- Must be completely supported by material beneath the portion parallel to the floor.

INSTALLATION INSTRUCTIONS

Step One: Dry fit trim pieces prior to installing floor to ensure proper fit and finish with flooring color variations.

Step Two: Glue the flooring to the entire step, trimming the locking mechanism from the piece on the edge of the tread.

Step Three: Using an adhesive appropriate for bonding two non-porous surfaces together, glue the stair nose to the edge of the installed flooring.

Step Four: Be sure to follow all curing instructions of the adhesive prior to using the steps.

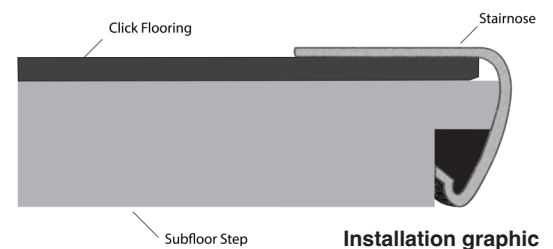

Stairnose (flush-mount)

SPECIFICATION & INSTALLATION

SPECIFICATIONS

Basic Dimensions: 2.01" (W) x 1.5" (H) x 84.5" (L)

Surface Material: PVC wearlayer with high-durability urethane coating

Core Material: Metal

Includes: Shim

APPLICATIONS

- Step up from a sunken area or steps

INSTALLATION INSTRUCTIONS

Step One: Dry fit trim pieces prior to installing floor to ensure proper fit and finish with flooring color variations.

Step Two: Glue and screw/staple the included shim directly on the edge of the step. The entire horizontal surfaces of the stairnose must be supported by the shim.

Step Three: Using ProVantage Heavy Duty Adhesive, adhere the stairnose to the shim, advising the packaging for proper curing instructions. A cut scrap piece of flooring can help you gauge the height of the installed stairnose.

Step Four: Trim the leading edge of the tongue as shown in Diagram A, to allow for a tight fit to the stairnose.

Step Five: Once ProVantage Heavy Duty Adhesive is cured in accordance with the instructions on the packaging, install the trimmed flooring flush to the molding.

On a step, glue the entire floor to the existing stair tread. For a step up to a larger area, glue the pieces adjacent to the stairnose and double the expansion space on the space parallel to the stairnose across the room. Increase the expansion space on the walls intersected by the extension of the stairnose by 50%.

PROFILE

Technical Dimensions/Profile:

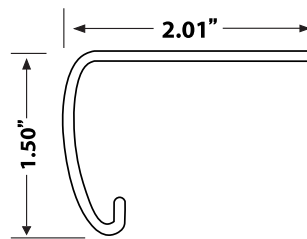

NOTES

- Recommended for residential use only.
- Must be completely supported by shim beneath the portion parallel to the floor.

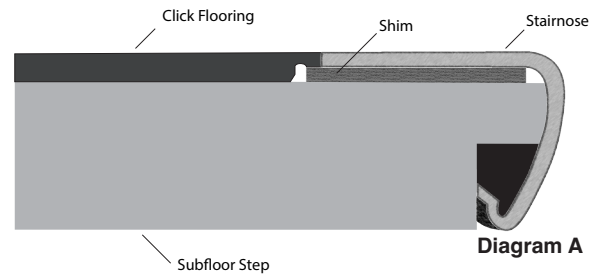

T-Mold

SPECIFICATION & INSTALLATION

SPECIFICATIONS

Basic Dimensions: 1.97" (W) x .31" (H) x 84.5" (L)

Surface Material: PVC wearlayer with high-durability urethane coating

Core Material: Extruded PVC Core

Includes: Metal Track

APPLICATIONS

- Two products of the same height
- Adding an expansion gap in large rooms

INSTALLATION INSTRUCTIONS

Step One: Dry fit trim pieces prior to installing floor to ensure proper fit and finish with flooring color variations.

Step Two: The metal track when installed needs to be far enough from the edge of the material to allow for the prescribed expansion space.

Step Three: Install the track with screws and/or glue to create a tight fit to the floor. Ensuring a tight fit to the floor could include trimming the base of the stem that engages into the metal track.

Step Four: Do not glue or fasten the molding directly to the material that would impede with the proper expansion and contraction of the product.

PROFILE

Technical Dimensions/Profile:

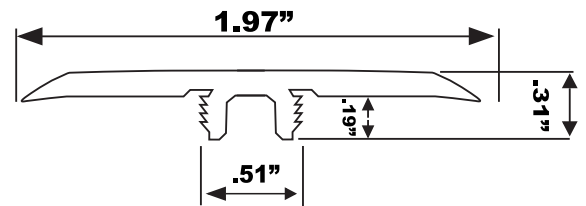

NOTES

- Recommended for residential use only.
- Track is not pre-drilled. Screws will easily penetrate the track.